

Bipolar IC

Overview

Features

- 2 × 0.7 amp. outputs
- Integrated driver, control logic and current control (chopper)
- Fast free-wheeling diodes
- Max. supply voltage 45 V
- Outputs free of crossover current
- Offset-phase turn-ON of output stages
- All outputs short-circuit proof
- 5 V output for logic supply
- Error-flag for overload, open load, overtemperature

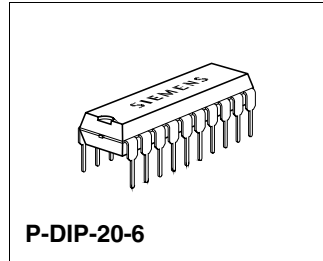

Type	Ordering Code	Package
TLE 4727	on request	P-DIP-20-6

Description

The TLE 4727 is a bipolar, monolithic IC for driving bipolar stepper motors, DC motors and other inductive loads that operate on constant current. The control logic and power output stages for two bipolar windings are integrated on a single chip which permits switched current control of motors with 0.7 A per phase at operating voltages up to 16 V.

The direction and value of current are programmable for each phase via separate control inputs. A common oscillator generates the timing for the current control and turn-on with phase offset of the two output stages. The two output stages in a full-bridge configuration include fast integrated free-wheeling diodes and are free of crossover current. The device can be driven directly by a microprocessor in several modes by programming phase direction and current control of each bridge independently.

A stabilized 5 V output allows the supply of external components up to 5 mA. With the error output the TLE 4727 signals malfunction of the device. Setting the control inputs high resets the error flag and by reactivating the bridges one by one the location of the error can be found.

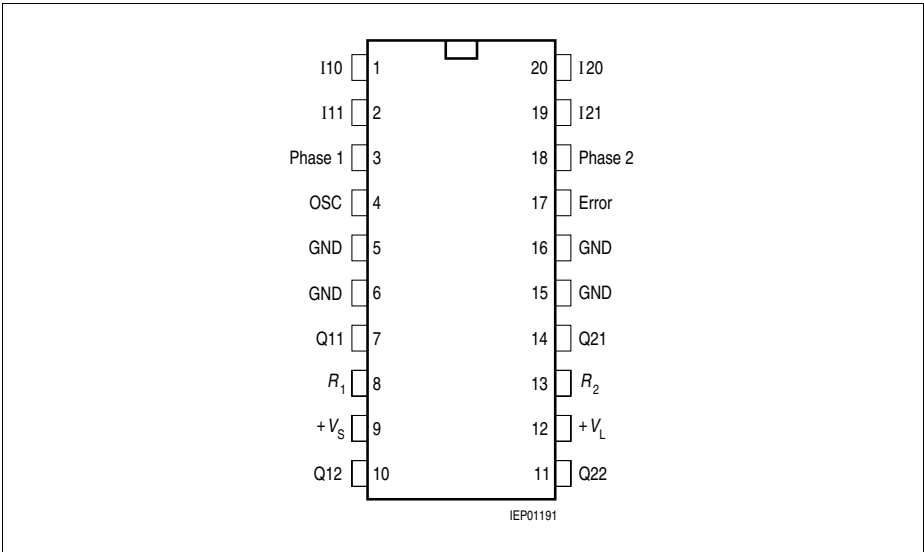

Figure 1 Pin Configuration (top view)

Pin Definitions and Functions

Pin No.	Function																				
1, 2, 19, 20	<p>Digital control inputs IX0, IX1 for the magnitude of the current of the particular phase.</p> <p>$I_{set} = 500 \text{ mA}$ with $R_{Sense} = 1 \Omega$</p> <table border="1"> <thead> <tr> <th>Current Control IX1</th> <th>IX0</th> <th>Phase Current</th> <th>Example of Motor Status</th> </tr> </thead> <tbody> <tr> <td>H</td> <td>H</td> <td>0</td> <td>No current ¹⁾</td> </tr> <tr> <td>H</td> <td>L</td> <td>$0.14 \times I_{set}$</td> <td>Hold</td> </tr> <tr> <td>L</td> <td>H</td> <td>I_{set}</td> <td>Normal mode</td> </tr> <tr> <td>L</td> <td>L</td> <td>$1.4 \times I_{set}$</td> <td>Accelerate</td> </tr> </tbody> </table> <p>¹⁾ "No current" in both bridges inhibits the circuit and current consumption will sink below 3 mA.</p>	Current Control IX1	IX0	Phase Current	Example of Motor Status	H	H	0	No current ¹⁾	H	L	$0.14 \times I_{set}$	Hold	L	H	I_{set}	Normal mode	L	L	$1.4 \times I_{set}$	Accelerate
Current Control IX1	IX0	Phase Current	Example of Motor Status																		
H	H	0	No current ¹⁾																		
H	L	$0.14 \times I_{set}$	Hold																		
L	H	I_{set}	Normal mode																		
L	L	$1.4 \times I_{set}$	Accelerate																		
3	Input Phase 1 ; controls the current through phase winding 1. On H-potential the phase current flows from Q11 to Q12, on L-potential in the reverse direction.																				
4	Oscillator ; works at typ. 25 kHz if this pin is wired to ground across 2.2 nF.																				
5, 6, 15, 16	Ground ; all pins are connected at leadframe internally.																				
7, 10	Push-pull outputs Q11, Q12 for phase 1 with integrated free-wheeling diodes.																				
8	Resistor R_1 for sensing the current in phase 1.																				
9	Supply voltage ; block to ground, as close as possible to the IC, with a stable electrolytic capacitor of at least 47 μF in parallel with a ceramic capacitor of 100 nF.																				
11, 14	Push-pull outputs Q22, Q21 for phase 2 with integrated free wheeling diodes.																				
12	Logic supply voltage ; internally generated 5 V voltage for logic supply up to 5 mA; short circuit protected. Block to ground with a stable electrolytic capacitor of 4.7 μF .																				
13	Resistor R_2 for sensing the current in phase 2.																				

Pin Definitions and Functions (cont'd)

Pin No.	Function
17	Error output ; signals with "low" the errors: open load or short circuit to ground of one or more outputs or short circuits of the load or overtemperature.
18	Input phase 2 ; controls the current flow through phase winding 2. On H-potential the phase current flows from Q21 to Q22, on L-potential in the reverse direction.

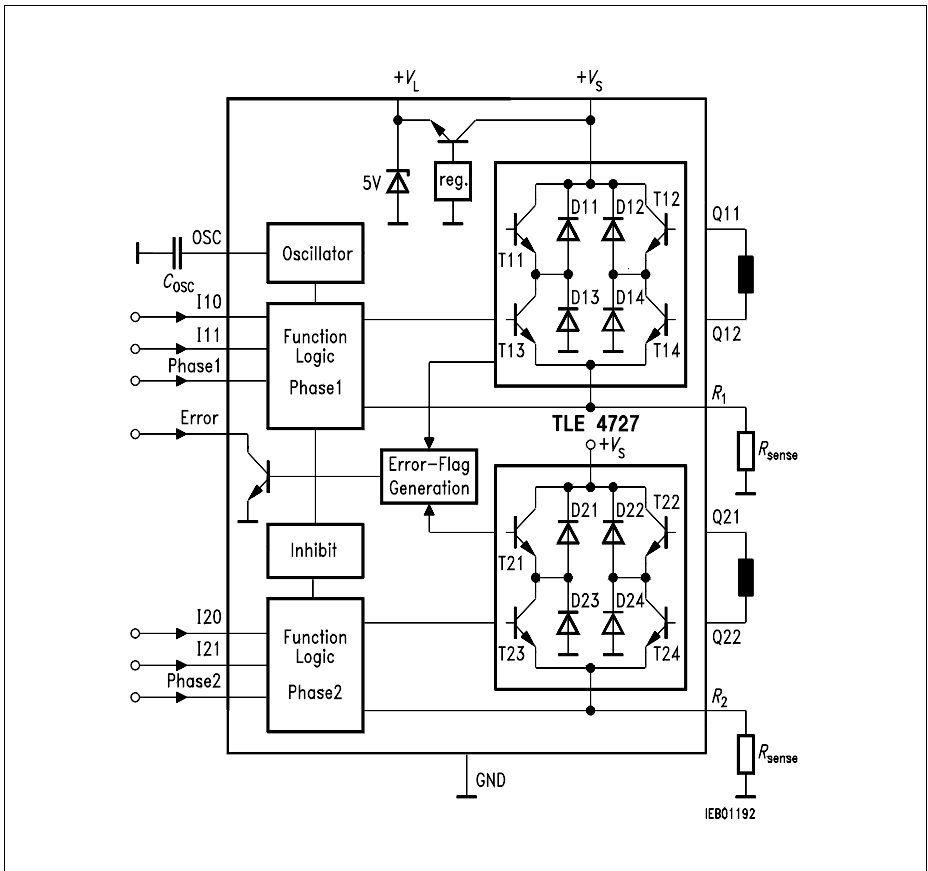

Figure 2 Block Diagram

Absolute Maximum Ratings

 Temperature $T_j = -40$ to 150 °C

Parameter	Symbol	Limit Values		Unit	Remarks
		min.	max.		
Supply voltage	V_S	- 0.3	45	V	–
Error outputs	V_{Err}	- 0.3	45	V	–
	I_{Err}	–	3	mA	–
Logic supply voltage	V_L	- 0.3	6.5	V	–
Output current of V_L	I_L	- 5	1) ¹⁾	mA	1) Int. limited
Output current	I_Q	- 1	1	A	–
Ground current	I_{GND}	- 2	–	A	–
Logic inputs	V_{IXX}	- 15	15	V	IXX ; Phase X
Oscillator voltage	V_{Osc}	- 0.3	6	V	–
R_1, R_2 input voltage	V_{RX}	- 0.3	5	V	–
Junction temperature	T_j	–	125	°C	–
	T_j	–	150	°C	Max. 10,000 h
Storage temperature	T_{stg}	- 50	125	°C	–
Thermal resistance					
Junction ambient	$R_{th\ ja}$	–	56	K/W	–
Junction ambient (soldered on a 35 µm thick 20 cm² PC board copper area)	$R_{th\ ja}$	–	40	K/W	–
Junction case	$R_{th\ jc}$	–	18	K/W	Measured on pin 5

Note: Stresses above those listed here may cause permanent damage to the device. Exposure to absolute maximum rating conditions for extended periods may affect device reliability.

Operating Range

Parameter	Symbol	Limit Values		Unit	Remarks
		min.	max.		
Supply voltage	V_S	5	16	V	–
Current from logic supply	I_L	–	5	mA	–
Case temperature	T_C	– 40	110	°C	Measured on pin 5 $P_{diss} = 2 \text{ W}$
Output current	I_Q	– 800	800	mA	–
Logic inputs	V_{IXX}	– 5	6	V	IXX ; Phase 1, 2
Error output	V_{Err}	–	25	V	–
	I_{Err}	0	1	mA	–

Note: In the operating range, the functions given in the circuit description are fulfilled.

Characteristics

$V_S = 6 \text{ to } 16 \text{ V}$; $T_j = -40 \text{ to } 130 \text{ °C}$

Parameter	Symbol	Limit Values			Unit	Test Condition
		min.	typ.	max.		

Current Consumption

from + V_S	I_S	1	2	3	mA	IXX = H
from + V_S	I_S	20	30	50	mA	IXX = L; $I_{Q1,2} = 0 \text{ A}$

Oscillator

Output charging current	I_{Osc}	90	120	135	μA	–
Charging threshold	V_{OscL}	0.8	1.3	1.9	V	–
Discharging threshold	V_{OscH}	1.7	2.3	2.9	V	–
Frequency	f_{Osc}	18	24	30	kHz	$C_{Osc} = 2.2 \text{ nF}$

Characteristics (cont'd)
 $V_S = 6 \text{ to } 16 \text{ V}; T_j = -40 \text{ to } 130 \text{ }^\circ\text{C}$

Parameter	Symbol	Limit Values			Unit	Test Condition
		min.	typ.	max.		

Phase Current ($V_S = 9 \text{ to } 16 \text{ V}$)

Mode "no current"	I_Q	-2	0	2	mA	IX0 = H; IX1 = H
Voltage threshold of current comparator at R_{sense} in mode:						
Hold	V_{ch}	40	70	100	mV	IX0 = L; IX1 = H
Setpoint	V_{cs}	450	500	570	mV	IX0 = H; IX1 = L
Accelerate	V_{ca}	630	700	800	mV	IX0 = L; IX1 = L

Logic Inputs (IX1 ; IX0 ; phase X)

Threshold	V_I	1.2	1.7	2.2	V	-
Hysteresis	V_{IHy}	-	50	-	mV	-
Low-input current	I_{IL}	-10	-1	1	μA	$V_I = 1.2 \text{ V}$
Low-input current	I_{IL}	-100	-20	-5	μA	$V_I = 0 \text{ V}$
High-input current	I_{IH}	-1	0	10	μA	$V_I = 5 \text{ V}$

Error Output

Saturation voltage	V_{ErrSat}	50	200	500	mV	$I_{Err} = 1 \text{ mA}$
Leakage current	I_{ErrL}	-	-	10	μA	$V_{Err} = 25 \text{ V}$

Logic Supply Output

Output voltage	V_L	4.5	5	6	V	$T_j < 150 \text{ }^\circ\text{C}$ $1 \text{ mA} < I_L < 5 \text{ mA}$ $V_S = 6 \text{ to } 45 \text{ V}$
----------------	-------	-----	---	---	---	---

Thermal Protection

Shutdown	T_{jsd}	140	150	160	$^\circ\text{C}$	$I_{Q1,2} = 0 \text{ A}$
Prealarm	T_{jpa}	120	130	140	$^\circ\text{C}$	$V_{Err} = \text{L}$
Delta	ΔT_j	10	20	30	K	$\Delta T_j = T_{jsd} - T_{jpa}$

Characteristics (cont'd)

 $V_S = 6 \text{ to } 16 \text{ V}; T_j = -40 \text{ to } 130 \text{ }^\circ\text{C}$

Parameter	Symbol	Limit Values			Unit	Test Condition
		min.	typ.	max.		

Power Output Sink
Diode Transistor Sink Pair
(D13, T13; D14, T14; D23, T23; D24, T24)

Saturation voltage	V_{satI}	0.1	0.4	0.6	V	$I_Q = -0.5 \text{ A}$
Saturation voltage	V_{satI}	0.2	0.5	0.8	V	$I_Q = -0.7 \text{ A}$
Reverse current	I_{RI}	500	1000	1500	μA	$V_S = V_Q = 40 \text{ V}$
Forward voltage	V_{FI}	0.6	0.95	1.25	V	$I_Q = 0.5 \text{ A}$
Forward voltage	V_{FI}	0.7	1	1.3	V	$I_Q = 0.7 \text{ A}$

Power Output Source
Diode Transistor Source Pair
(D11, T11; D12, T12; D21, T21; D22, T22)

Saturation voltage; charge	V_{satuC}	0.6	1.1	1.3	V	$I_Q = 0.5 \text{ A}$
Saturation voltage; discharge	V_{satuD}	0.1	0.4	0.7	V	$I_Q = 0.5 \text{ A}$
Saturation voltage; charge	V_{satuC}	0.7	1.2	1.5	V	$I_Q = 0.7 \text{ A}$
Saturation voltage; discharge	V_{satuD}	0.2	0.5	0.8	V	$I_Q = 0.7 \text{ A}$
Reverse current	I_{Ru}	400	800	1200	μA	$V_S = 40 \text{ V},$ $V_Q = 0 \text{ V}$
Forward voltage	V_{Fu}	0.7	1.05	1.35	V	$I_Q = -0.5 \text{ A}$
Forward voltage	V_{Fu}	0.8	1.1	1.4	V	$I_Q = -0.7 \text{ A}$
Diode leakage current	I_{SL}	0	3	10	mA	$I_F = -0.7 \text{ A}$

Note: The listed characteristics are ensured over the operating range of the integrated circuit. Typical characteristics specify mean values expected over the production spread. If not otherwise specified, typical characteristics apply at $T_A = 25 \text{ }^\circ\text{C}$ and the given supply voltage.

Quiescent Current I_S versus Supply Voltage

V_S ; bridges not chopping; $T_j = 25^\circ\text{C}$

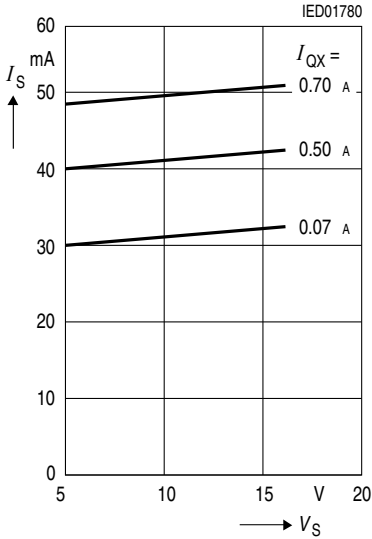

Quiescent Current I_S versus Junction Temp.

T_j ; bridges not chopping; $V_S = 14\text{ V}$

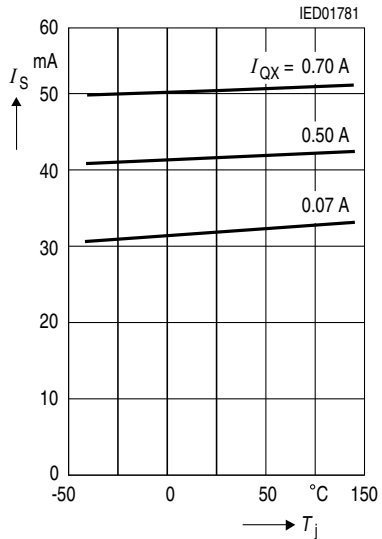

Oscillator Frequency f_{OSC} versus Junction Temperature T_j

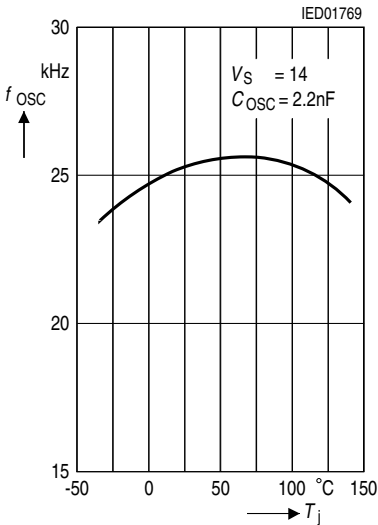

Output Current I_{Ox} versus Junction Temperature T_j

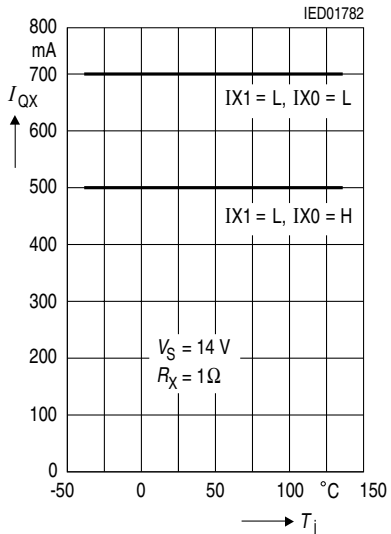

Output Saturation Voltages V_{sat} versus Output Current I_Q

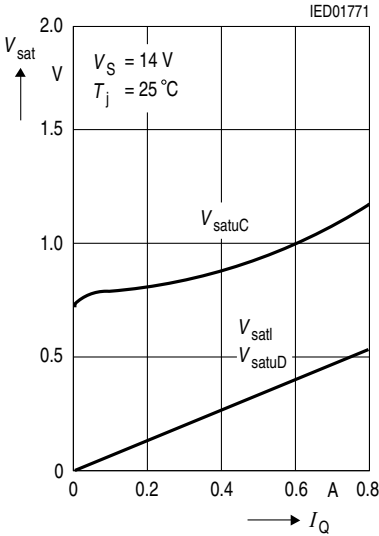

Forward Current I_F of Free-Wheeling Diodes versus Forward Voltages V_F

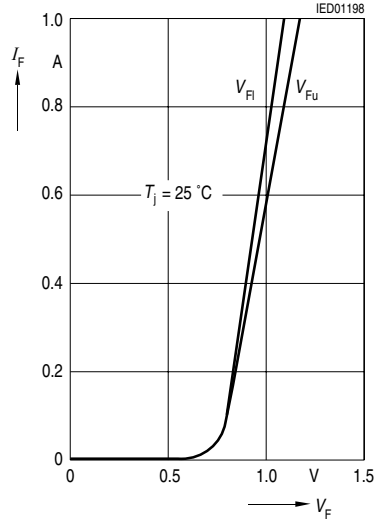

Typical Power Dissipation P_{tot} versus Output Current I_Q (non stepping)

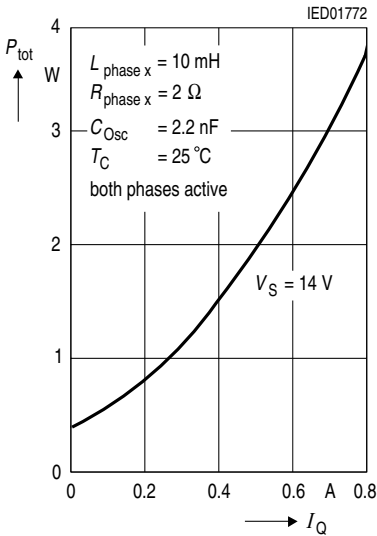

Permissible Power Dissipation P_{tot} versus Case Temp. T_C (measured at pin 5)

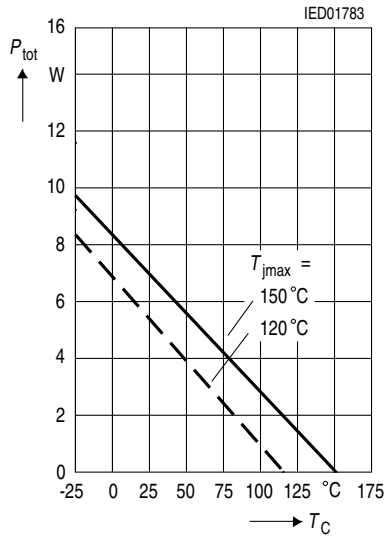

Input Characteristics of IXX , Phase X

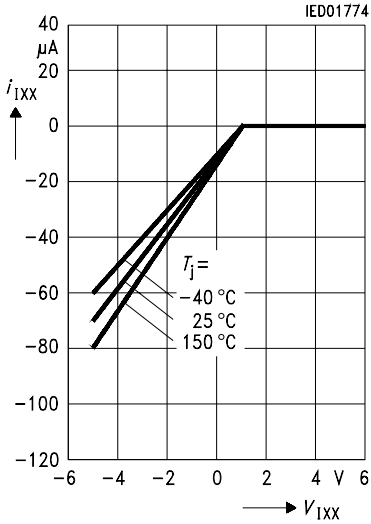

Output Leakage Current

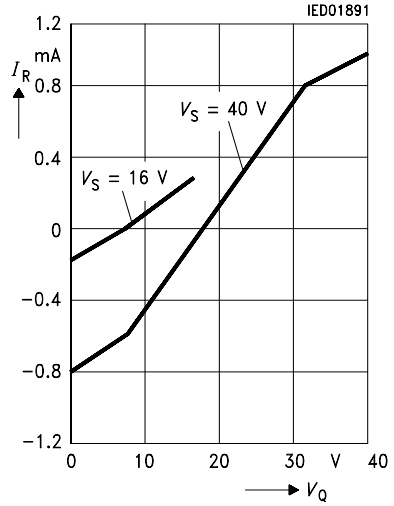

Logic Supply Output Voltage versus Output Current I_L

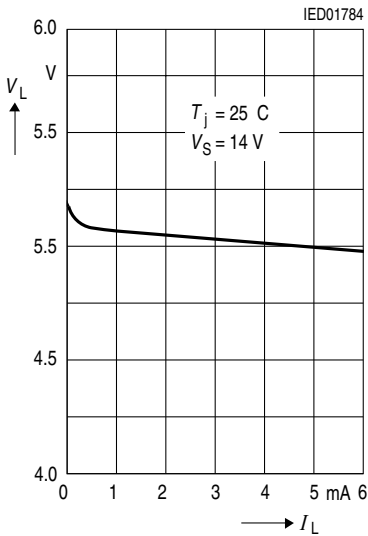

Logic Supply Output Voltage versus Junction Temperature T_j

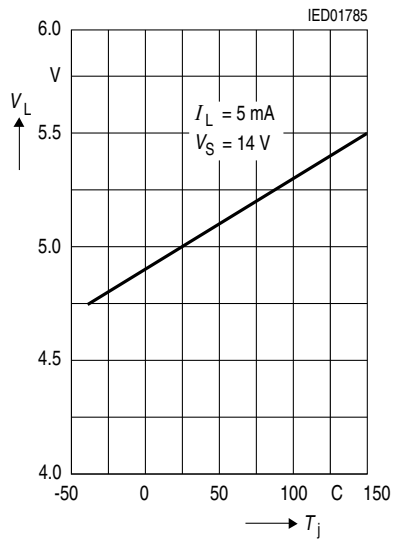

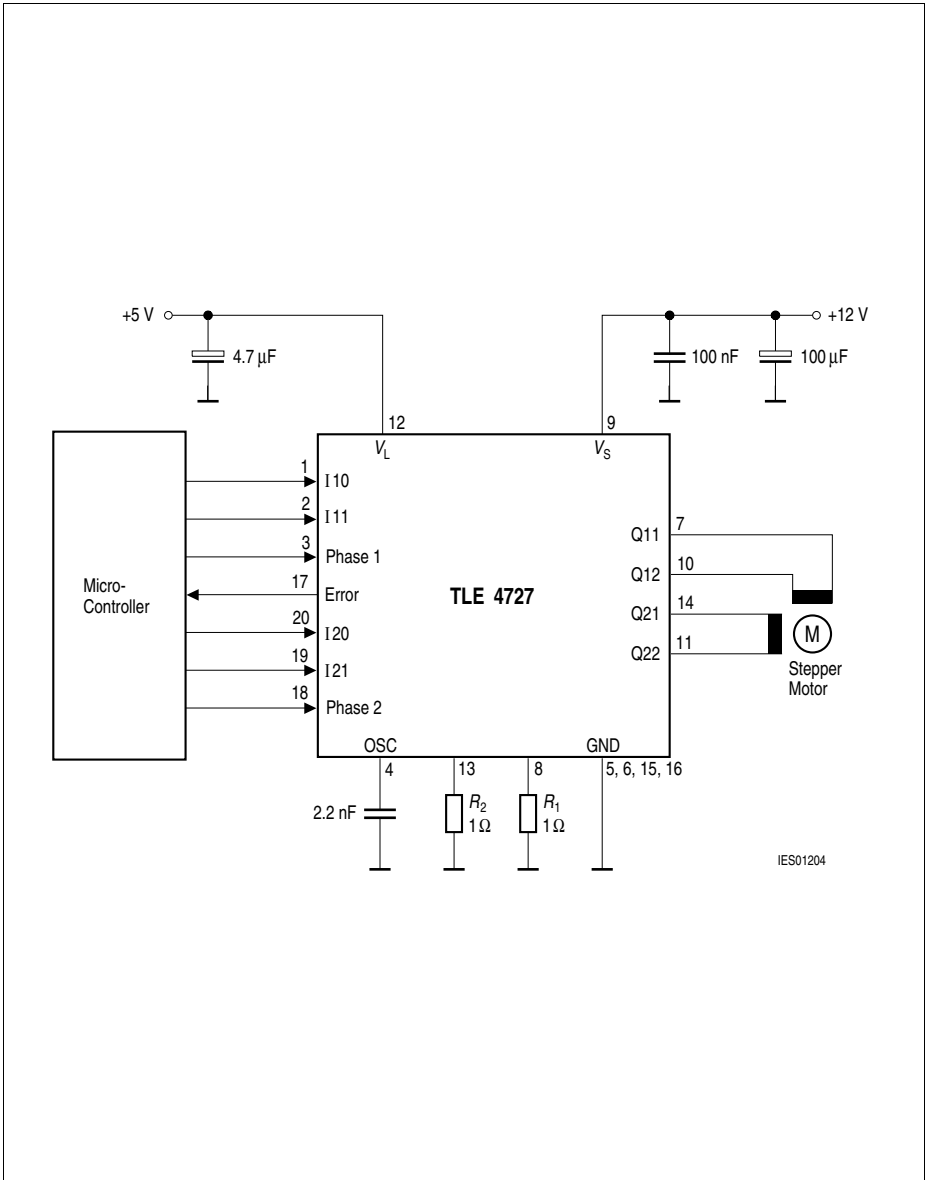

Figure 3 Application Circuit

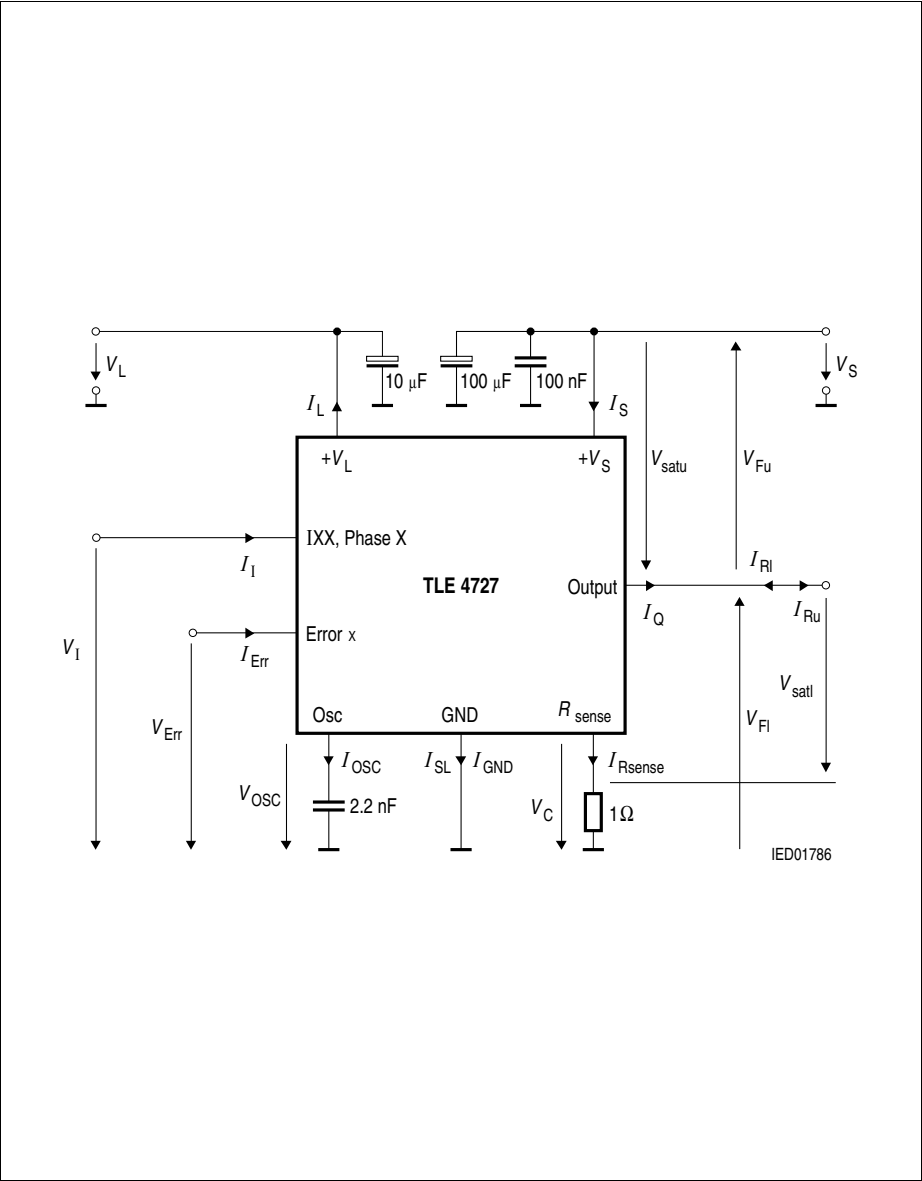

Figure 4 Test Circuit

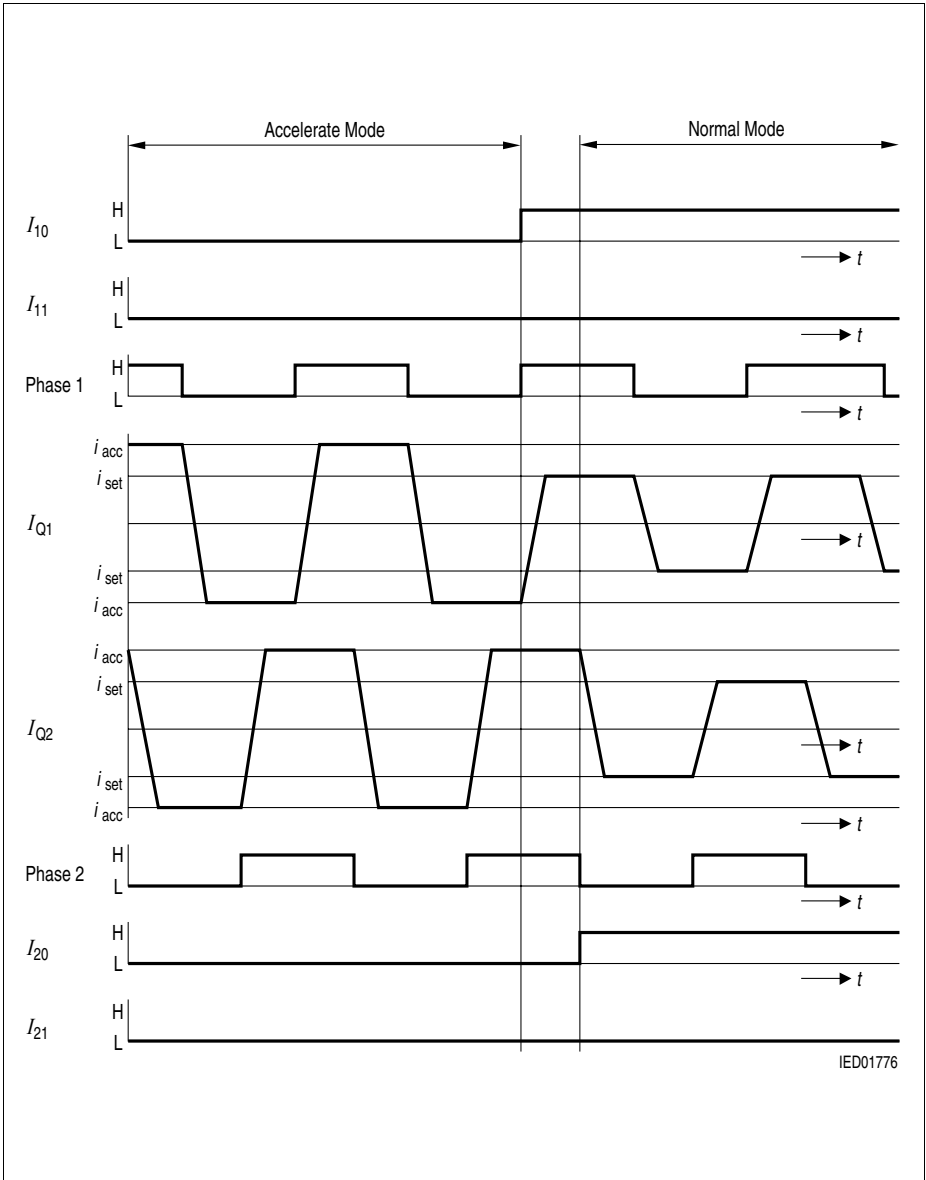

Figure 5 Full-Step Operation

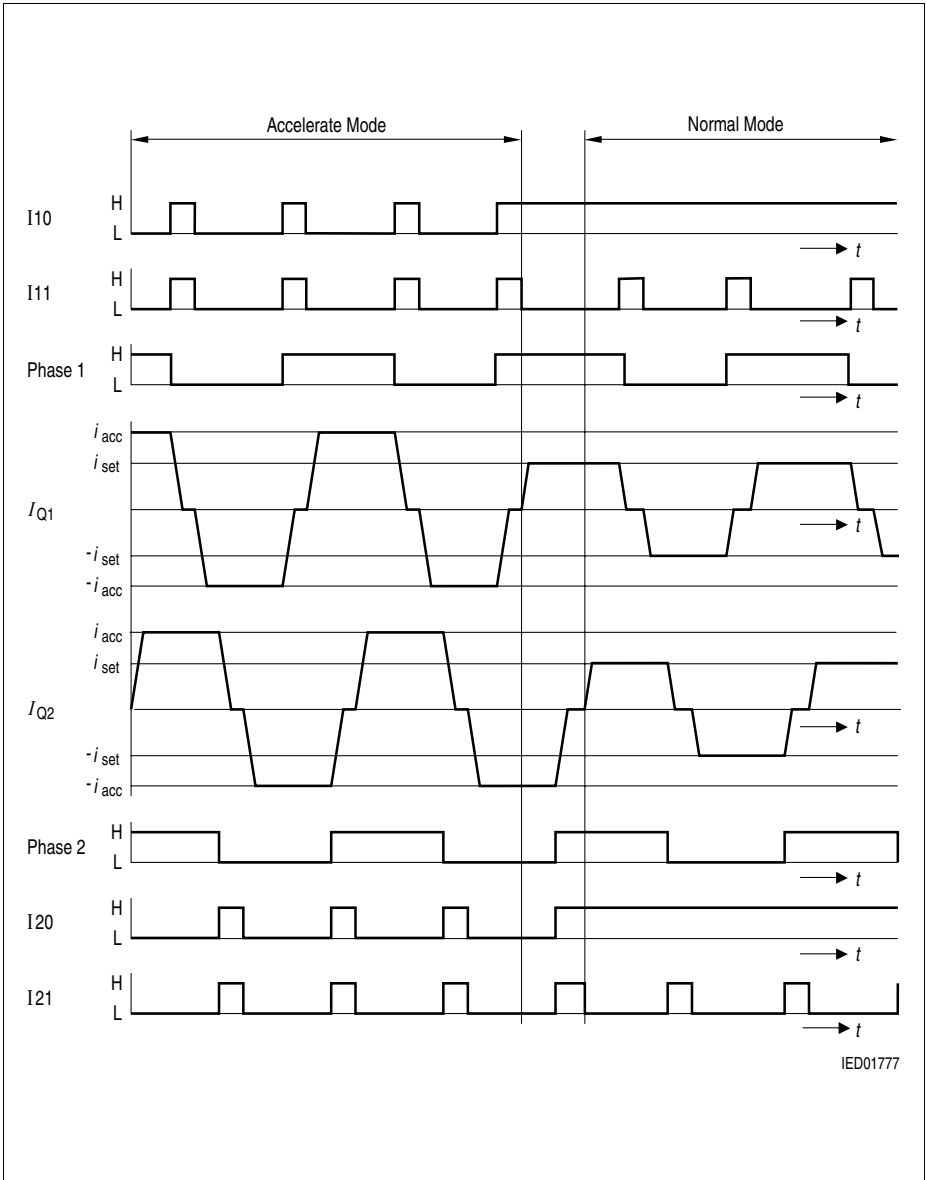

Figure 6 Half-Step Operation

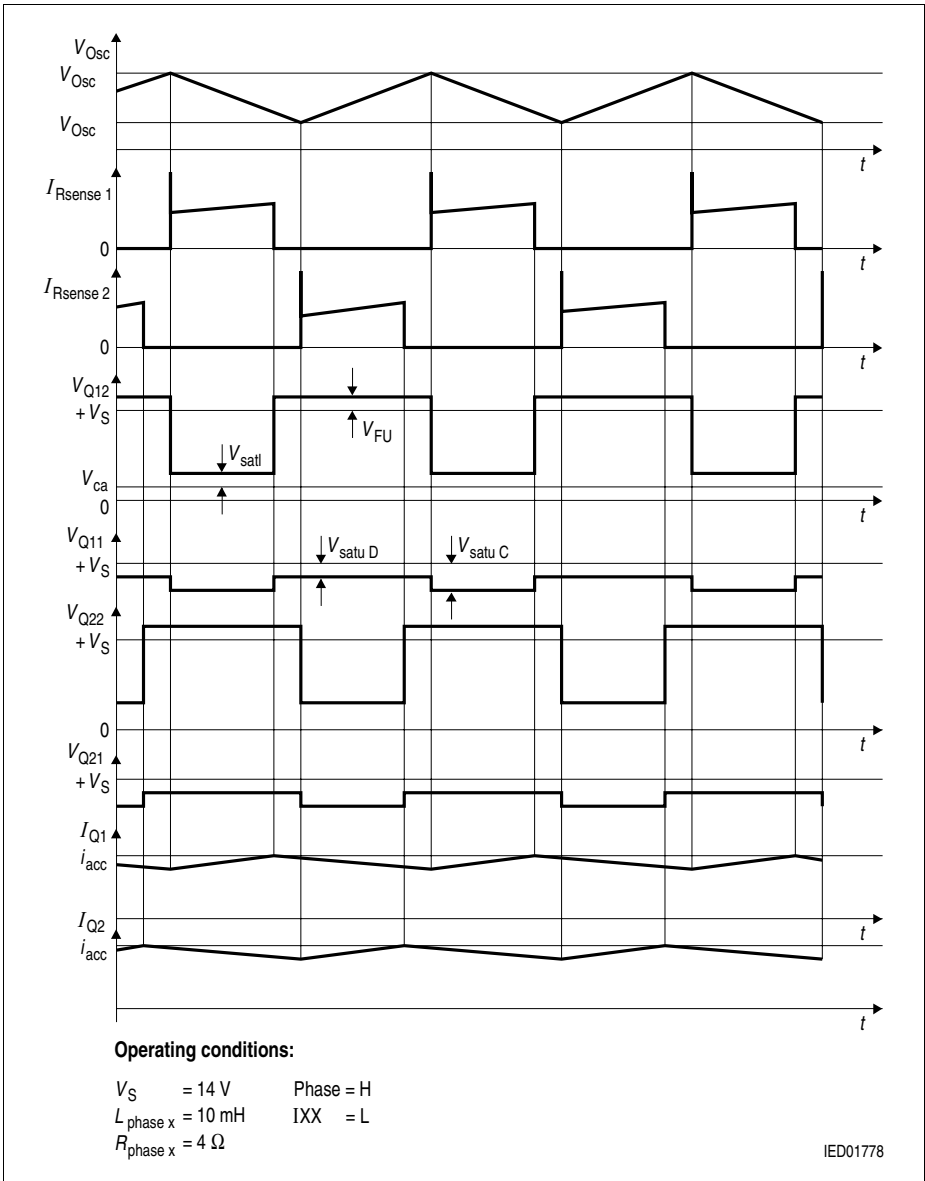

Figure 7 Current Control in Chop-Mode

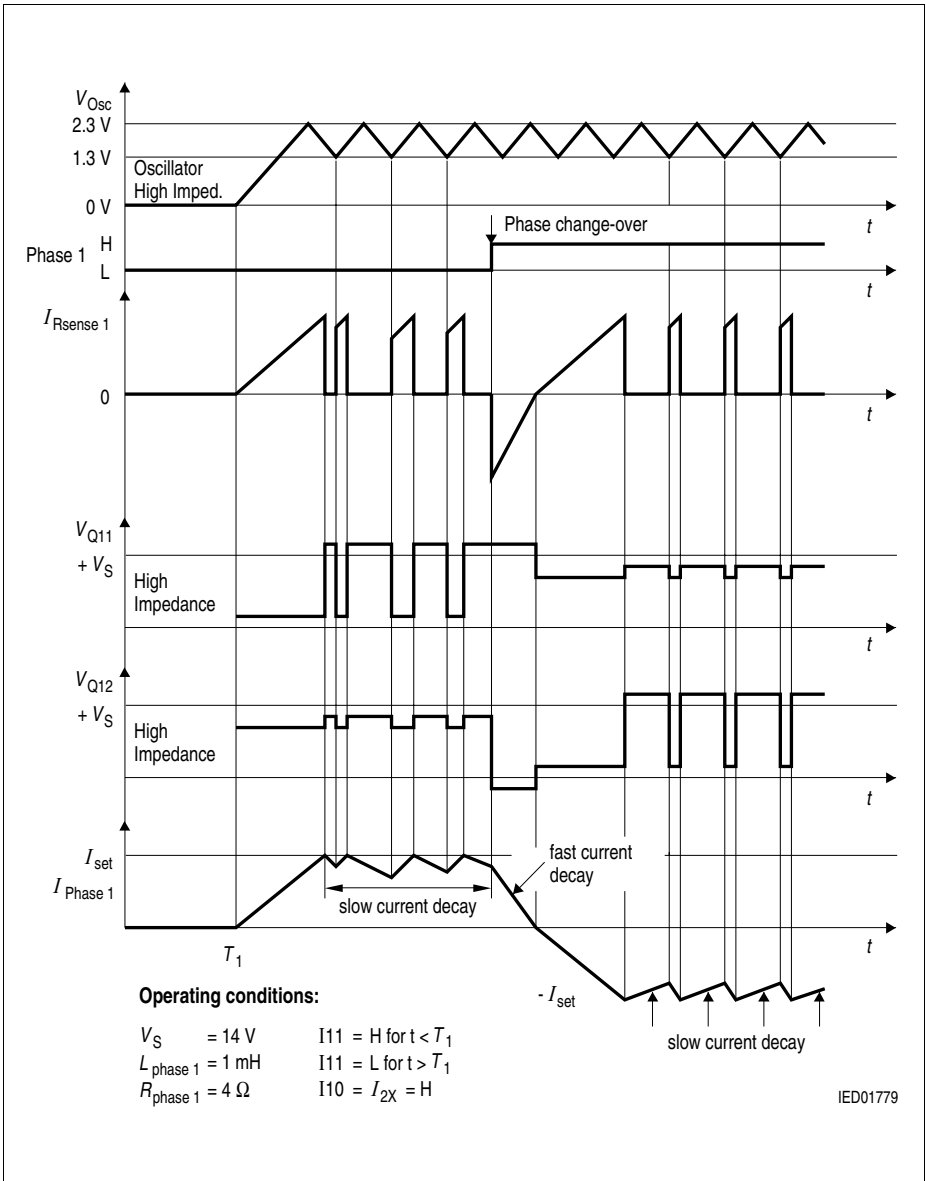

Figure 8 Phase Reversal and Inhibit

Calculation of Power Dissipation

The total power dissipation P_{tot} is made up of

- saturation losses** P_{sat} (transistor saturation voltage and diode forward voltages),
- quiescent losses** P_{q} (quiescent current times supply voltage) and
- switching losses** P_{s} (turn-ON / turn-OFF operations).

The following equations give the power dissipation for chopper operation without phase reversal. This is the worst case, because full current flows for the entire time and switching losses occur in addition.

$$P_{\text{tot}} = 2 \times P_{\text{sat}} + P_{\text{q}} + 2 \times P_{\text{s}}$$

where
$$P_{\text{sat}} \cong I_{\text{N}} \{V_{\text{satl}} \times d + V_{\text{Fu}} (1 - d) + V_{\text{satuC}} \times d + V_{\text{satuD}} (1 - d)\}$$

$$P_{\text{q}} = I_{\text{q}} \times V_{\text{S}}$$

$$P_{\text{s}} \cong \frac{V_{\text{S}}}{T} \left\{ \frac{i_{\text{D}} \times t_{\text{DON}}}{2} + \frac{(i_{\text{D}} + i_{\text{R}}) \times t_{\text{ON}}}{4} + \frac{I_{\text{N}}}{2} (t_{\text{DOFF}} + t_{\text{OFF}}) \right\}$$

I_{N} = nominal current (mean value)

I_{q} = quiescent current

i_{D} = reverse current during turn-ON delay

i_{R} = peak reverse current

t_{p} = conducting time of chopper transistor

t_{ON} = turn-ON time

t_{OFF} = turn-OFF time

t_{DON} = turn-ON delay

t_{DOFF} = turn-OFF delay

T = cycle duration

d = duty cycle t_{p} / T

V_{satl} = saturation voltage of sink transistor (T_{X3} , T_{X4})

V_{satuC} = saturation voltage of source transistor (T_{X1} , T_{X2}) during charge cycle

V_{satuD} = saturation voltage of source transistor (T_{X1} , T_{X2}) during discharge cycle

V_{Fu} = forward voltage of free-wheeling diode (D_{X1} , D_{X2})

V_{S} = supply voltage

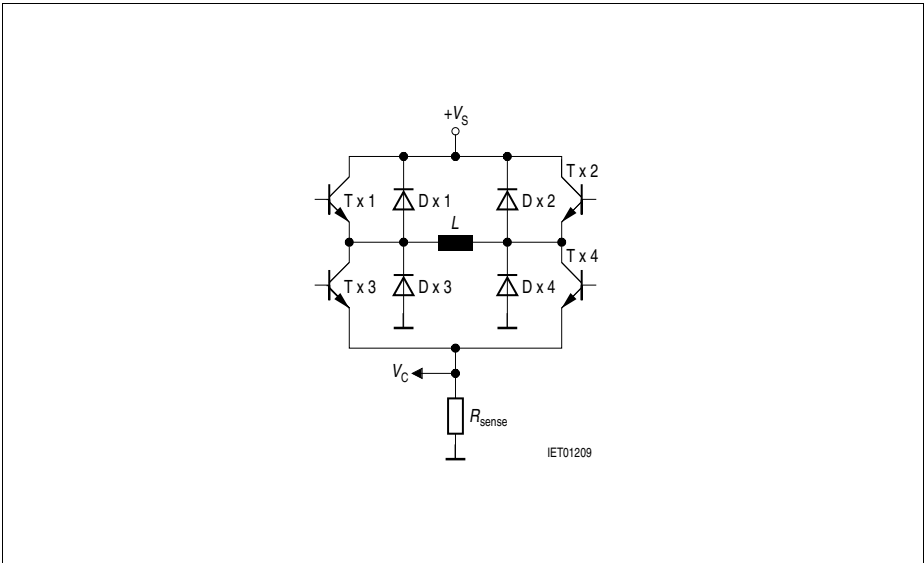

Figure 9

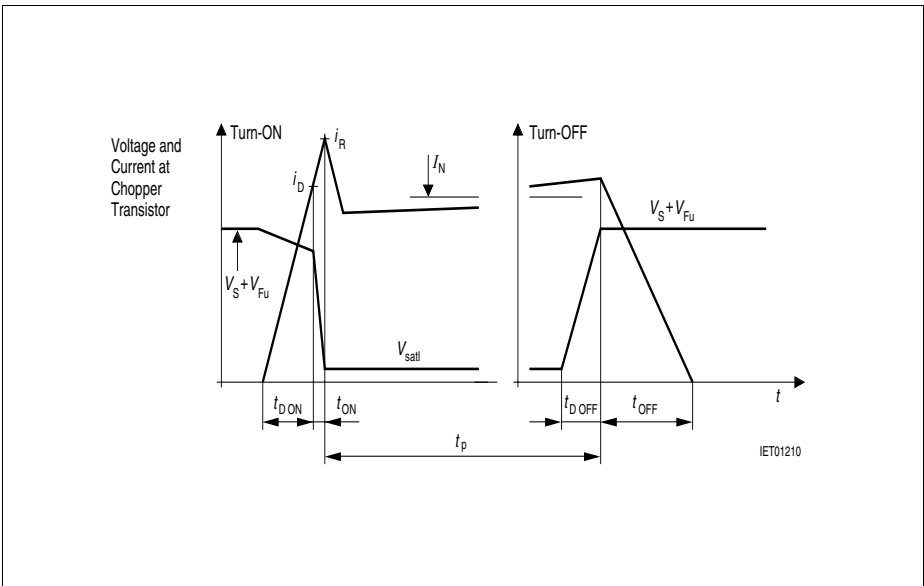

Figure 10 Voltage and Current at Chopper Transistor

Application Hints

The TLE 4727 is intended to drive both phases of a stepper motor. Special care has been taken to provide high efficiency, robustness and to minimize external components.

Power Supply

The TLE 4727 will work with supply voltages ranging from 5 V to 16 V at pin V_S . Surges exceeding 16 V at V_S won't harm the circuit up to 45 V, but whole function is not guaranteed. As soon as the voltage drops below approximately 16 V the TLE 4727 works promptly again.

As the circuit operates with chopper regulation of the current, interference generation problems can arise in some applications. Therefore the power supply should be decoupled by a 0.1 μF ceramic capacitor located near the package. Unstabilized supplies may even afford higher capacities.

Current Sensing

The current in the windings of the stepper motor is sensed by the voltage drop across R_{sense} . Depending on the selected current internal comparators will turn off the sink transistor as soon as the voltage drop reaches certain thresholds (typical 0 V, 0.07 V, 0.50 V and 0.70 V). These thresholds are not affected by variations of V_S . Consequently unstabilized supplies will not affect the performance of the regulation. For precise current level it must be considered, that internal bonding wire (typ. 60 m Ω) is a part of R_{sense} .

Due to chopper control fast current rises (up to 10A/ μs) will occur at the sensing resistors. To prevent malfunction of the current sensing mechanism R_{sense} should be pure ohmic. The resistors should be wired to GND as directly as possible. Capacitive loads such as long cables (with high wire to wire capacity) to the motor should be avoided for the same reason.

Synchronizing Several Choppers

In some applications synchronous chopping of several stepper motor drivers may be desirable to reduce acoustic interference. This can be done by forcing the oscillator of the TLE 4727 by a pulse generator overdriving the oscillator loading currents (approximately $\pm 120 \mu\text{A}$). In these applications low level should be between 0 V and 0.8 V while high level should be between 3 V and 5 V.

Optimizing Noise Immunity

Unused inputs should always be wired to proper voltage levels in order to obtain highest possible noise immunity.

To prevent crossconduction of the output stages the TLE 4727 uses a special break before make timing of the power transistors. This timing circuit can be triggered by short glitches (some hundred nanoseconds) at the Phase inputs causing the output stage to become high resistive during some microseconds. This will lead to a fast current decay during that time. To achieve maximum current accuracy such glitches at the Phase inputs should be avoided by proper control signals.

To lower EMI a ceramic capacitor of max. 3 nF is advisable from each output to GND.

Thermal Shut Down

To protect the circuit against thermal destruction, thermal shut down has been implemented.

Error Monitoring

The error output signals with low-potential one of the following errors:

- overtemperature** implemented as pre-alarm; appears approximately 20 K before thermal shut down.
- short circuit** a connection of one output to GND for longer than 30 μ s sets an internal error flipflop. A phase change-over of the affected bridge resets the flipflop. Being a separate flipflop for each bridge, the error can be located in such way.
- underload** the recirculation of the inductive load is watched. If there is no recirculation after a phase change-over, the internal error flipflop is set. Additionally an error is signaled after a phase change-over during hold-mode.

Package Outlines

P-DIP-20-6
(Plastic Dual In-line Package)

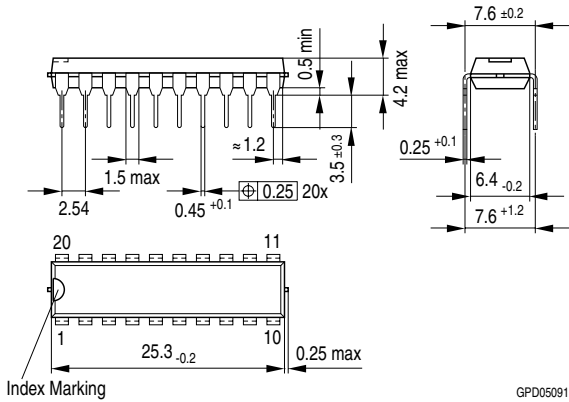

Sorts of Packing

Package outlines for tubes, trays etc. are contained in our Data Book "Package Information".

Dimensions in mm